

## 2.4mm Fixed Attenuator, DC - 50GHz, 2Watts

P/N: FR4-2.4-CA1XXE

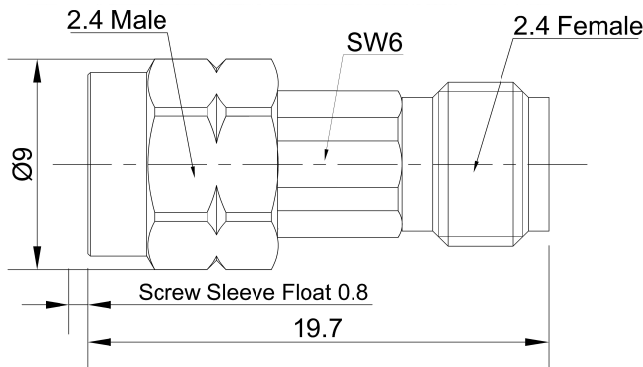

Dimensions are in mm

## Electrical Performance Parameter Table

Product No	Frequency	Attenuation Value (dB)	Attenuation Accuracy (dB)	VSWR	AVERAGE POWER (W)
2.4-CA101-E	DC-50GHz	1	-1.0/+1.0	1.3	2 @25°C
2.4-CA102-E	DC-50GHz	2	-1.0/+1.0	1.3	2 @25°C
2.4-CA103-E	DC-50GHz	3	-1.0/+1.0	1.3	2 @25°C
2.4-CA104-E	DC-50GHz	4	-1.0/+1.0	1.3	2 @25°C
2.4-CA105-E	DC-50GHz	5	-1.0/+1.0	1.3	2 @25°C
2.4-CA106-E	DC-50GHz	6	-1.0/+1.0	1.3	2 @25°C
2.4-CA107-E	DC-50GHz	7	-1.0/+1.0	1.3	2 @25°C
2.4-CA108-E	DC-50GHz	8	-1.0/+1.0	1.3	2 @25°C
2.4-CA109-E	DC-50GHz	9	-1.0/+1.0	1.3	2 @25°C
2.4-CA110-E	DC-50GHz	10	-1.0/+1.0	1.3	2 @25°C
2.4-CA120-E	DC-50GHz	20	-1.0/+1.2	1.3	2 @25°C
2.4-CA130-E	DC-50GHz	30	-1.0/+1.2	1.3	2 @25°C

## Product Configuration

Connector-In Series	2.4mm
Connector-Out Series	2.4mm
Connector-In Polarity	Standard
Connector-Out Polarity	Standard
Connector-In Gender	Male
Connector-Out Gender	Female
Connector-In Impedance (Ohm)	50
Connector-Out Impedance (Ohm)	50